



Message Implementation Guideline

Mercedes Benz – Daimler Truck EDIFACT DESADV

based on

DESADV

Despatch advice message

UN D.96A S3

Version: 8.2
Issue date: 11.09.2023

EDI Customer Support:

Phone: +49 391 5976 2016
Phone: +1 866 405 5305 (US only)
E-Fax: +49 391 580 211 271
E-Mail: edi.hotline@t-systems.com

Structure / Table of Contents

Counter	No	Tag	St	MaxOcc	Level	Content
0000	1	UNA	C	1	0	SERVICE STRING ADVICE
0000	2	UNB	M	1	0	INTERCHANGE HEADER
0010	3	UNH	M	1	0	MESSAGE HEADER
0020	4	BGM	M	1	0	Beginning of message
0030	5	DTM	R	3	1	DTM - Shipping Date
0030	6	DTM	R	3	1	DTM - Estimated date/time of arrival (ETA)
0030	7	DTM	R	3	1	DTM - Message Creation Date
0050	8	MEA	R	3	1	MEA - Gross weight
0050	9	MEA	O	3	1	MEA - Net weight
0050	10	MEA	O	3	1	MEA - Space of loading
0070		SG1	O	3	1	RFF - Transmission number, new
0080	11	RFF	M	1	1	Reference
0090	12	DTM	O	1	2	Date/time/period
0070		SG1	O	3	1	RFF - Transmission number, old
0080	13	RFF	M	1	1	Reference
0070		SG1	R	3	1	RFF - Consignment number
0080	14	RFF	M	1	1	Reference
0070		SG1	R	3	1	RFF - Related document number
0080	14	RFF	M	1	1	Reference
0100		SG2	R	7	1	NAD - Buyer
0110	15	NAD	M	1	1	Name and address
0100		SG2	R	7	1	NAD - Consignee
0110	16	NAD	M	1	1	Name and address
0120	17	LOC	R	10	2	Place/location identification
0160		SG4	R	10	2	CTA
0170	18	CTA	M	1	2	Contact information
0100		SG2	D	7	1	NAD - Vendor
0110	19	NAD	M	1	1	Name and address
0120	20	LOC	R	10	2	Place/location identification
0100		SG2	O	7	1	NAD - Consignor
0110	21	NAD	M	1	1	Name and address
0100		SG2	R	7	1	NAD - Forwarder
0110	22	NAD	M	1	1	Name and address
0100		SG2	R	7	1	NAD - Seller
0110	23	NAD	M	1	1	Name and address
0100		SG2	D	7	1	NAD - Delivery Party
0110	24	NAD	M	1	1	Name and address
0190		SG5	R	10	1	TOD
0200	25	TOD	M	1	1	Terms of delivery or transport

Counter = Counter of segment/group within the standard
 No = Consecutive segment number
 MaxOcc = Maximum occurrence of the segment/group

St = Status
 EDIFACT: M=Mandatory, C=Conditional
 User specific: R=Required, O=Optional, D=Dependent,
 A=Advised, N=Not used

Counter	No	Tag	St	MaxOcc	Level	Content
	0230	SG6	R	10	1	TDT
	0240	26 TDT	M	1	1	Details of transport
	0370	SG10	R	9999	1	CPS-SG11-SG15
	0380	27 CPS	M	1	1	Consignment packing sequence
	0400	SG11	D	9999	2	PAC-MEA-QTY-SG13
	0410	28 PAC	M	1	2	Package
	0420	29 MEA	O	10	3	Measurements
	0430	30 QTY	D	10	3	Quantity
	0470	SG13	D	1000	3	PCI-GIR-SG14
	0480	31 PCI	M	1	3	Package identification
	0510	32 GIR	D	99	4	Related identification numbers
	0520	SG14	D	99	4	GIN
	0530	33 GIN	M	1	4	Goods identity number
	0550	SG15	R	1	2	LIN-PIA-MEA-QTY-ALI-GIN-DTM-FTX-SG16-SG18
	0560	34 LIN	M	1	2	Line item
	0570	35 PIA	O	10	3	Additional product id
	0590	36 MEA	O	10	3	Measurements
	0600	37 QTY	R	10	3	Quantity
	0610	38 ALI	R	10	3	Additional information
	0620	39 GIN	D	100	3	Goods identity number
	0650	40 DTM	C	5	3	Minimum Shelf Life
	0650	41 DTM	D	5	3	Drawing date
	0660	42 FTX	O	1	3	Free text
	0660	43 FTX	D	5	3	Additional information
	0660	44 FTX	D	1	3	General information
	0660	45 FTX	O	1	3	VAT rate
	0660	46 FTX	D	1	3	Additional attribute information
	0660	47 FTX	D	1	3	Engineering change notice
	0680	SG16	R	10	3	RFF - Order Number
	0690	48 RFF	M	1	3	Reference
	0680	SG16	R	10	3	RFF - sub-Assembly number
	0690	49 RFF	D	1	3	Reference
	0750	SG18	O	100	3	LOC - Storage Location
	0760	50 LOC	M	1	3	Place/location identification
	0990	51 UNT	M	1	0	MESSAGE TRAILER
	0000	52 UNZ	M	1	0	INTERCHANGE TRAILER

Counter = Counter of segment/group within the standard
 No = Consecutive segment number
 MaxOcc = Maximum occurrence of the segment/group

St = Status
 EDIFACT: M=Mandatory, C=Conditional
 User specific: R=Required, O=Optional, D=Dependent,
 A=Advised, N=Not used

Branching Diagram of Used Segments/Groups

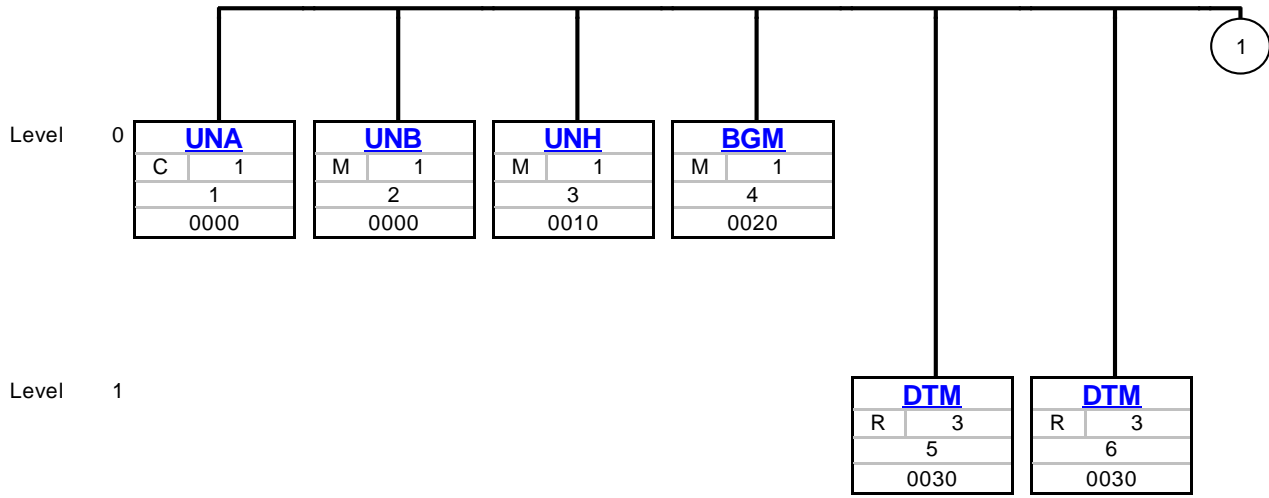

Tag
St MaxOcc
No
Counter

Tag = Segment/Group Tag
 St = Status (M=Mandatory, C=Conditional, R=Required, O=Optional, A=Advised, D=Dependent)
 MaxOcc = Maximum occurrence of the segment/group
 No = Consecutive segment number
 Counter = Counter of segment/group within the standard

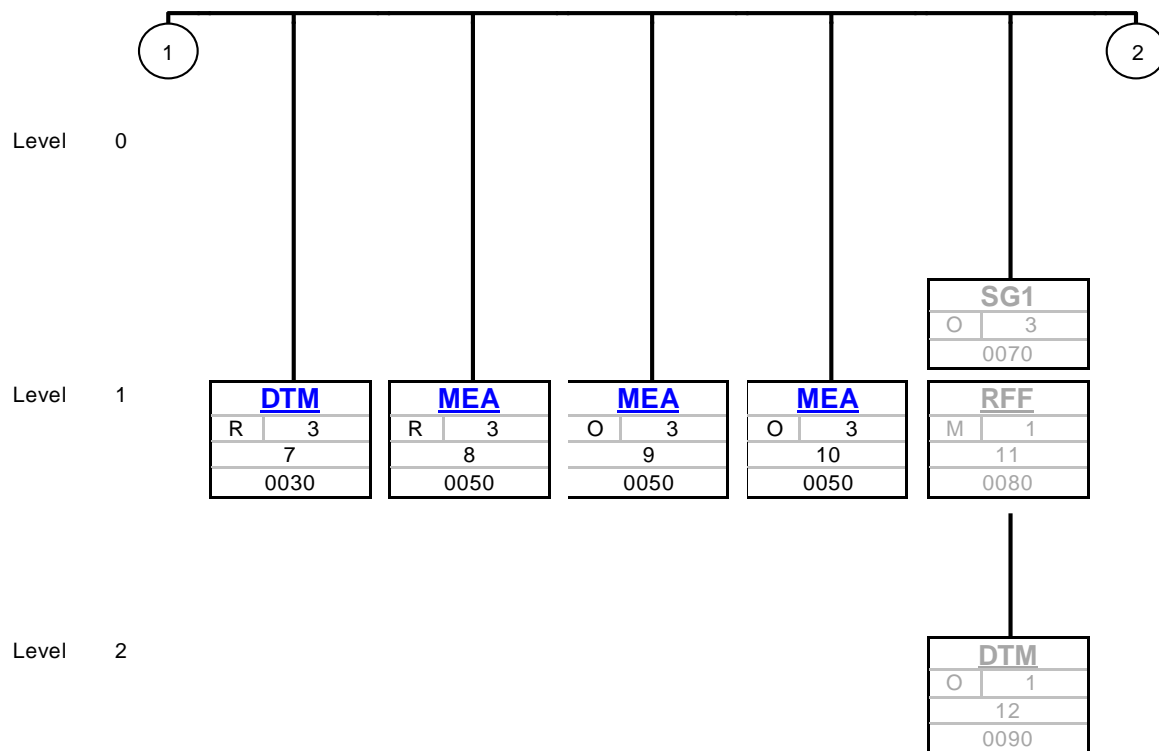

Tag
St MaxOcc
No
Counter

Tag = Segment/Group Tag
 St = Status (M=Mandatory, C=Conditional, R=Required, O=Optional, A=Advised, D=Dependent)
 MaxOcc = Maximum occurrence of the segment/group
 No = Consecutive segment number
 Counter = Counter of segment/group within the standard

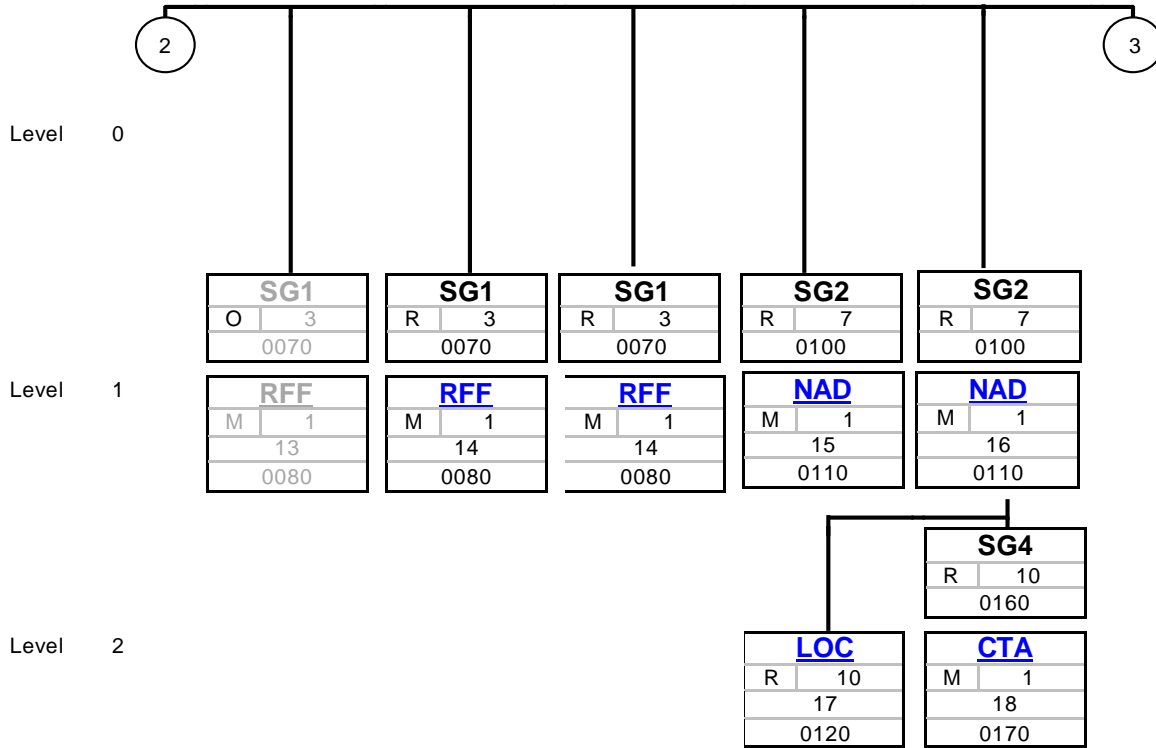

Tag
St MaxOcc
No
Counter

Tag = Segment/Group Tag
 St = Status (M=Mandatory, C=Conditional, R=Required, O=Optional, A=Advised, D=Dependent)
 MaxOcc = Maximum occurrence of the segment/group
 No = Consecutive segment number
 Counter = Counter of segment/group within the standard

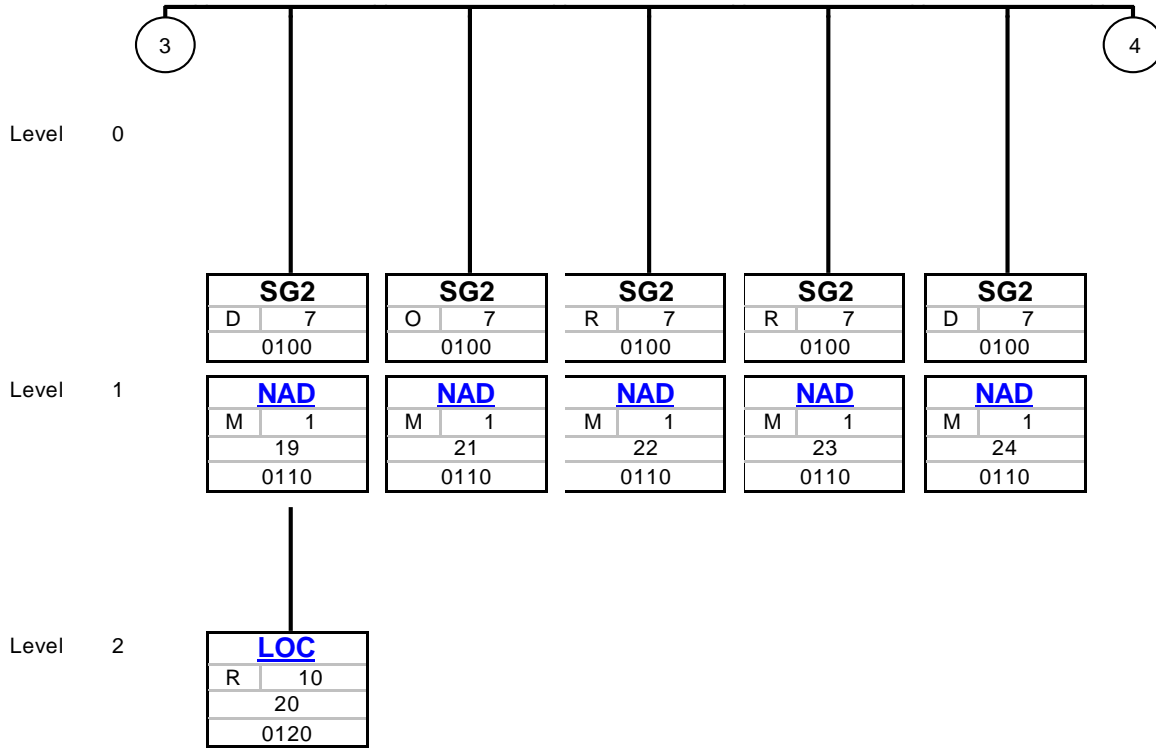

Tag
St MaxOcc
No
Counter

Tag = Segment/Group Tag
 St = Status (M=Mandatory, C=Conditional, R=Required, O=Optional, A=Advised, D=Dependent)
 MaxOcc = Maximum occurrence of the segment/group
 No = Consecutive segment number
 Counter = Counter of segment/group within the standard

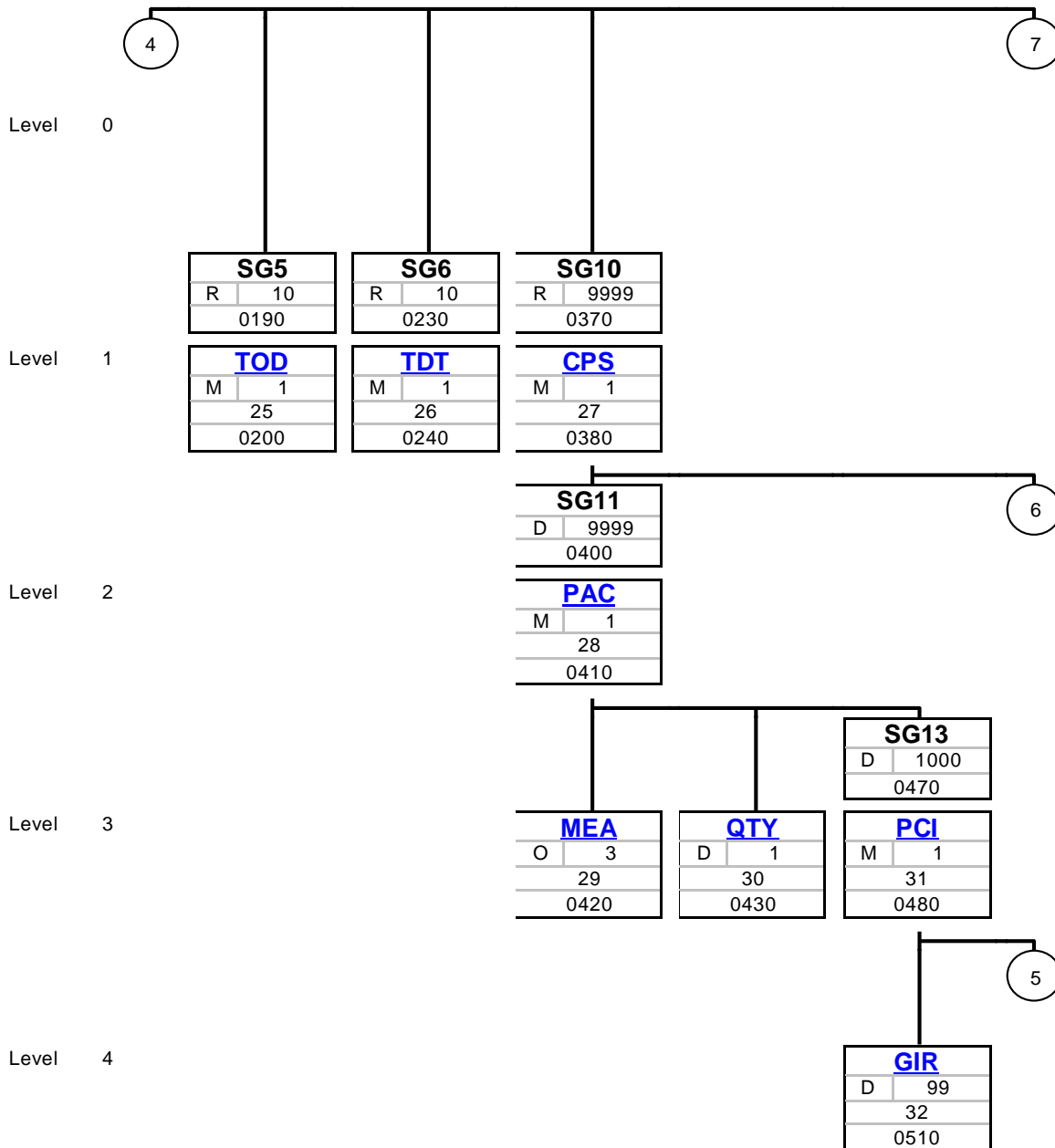

Tag
St MaxOcc
No
Counter

Tag = Segment/Group Tag
 St = Status (M=Mandatory, C=Conditional, R=Required, O=Optional, A=Advised, D=Dependent)
 MaxOcc = Maximum occurrence of the segment/group
 No = Consecutive segment number
 Counter = Counter of segment/group within the standard

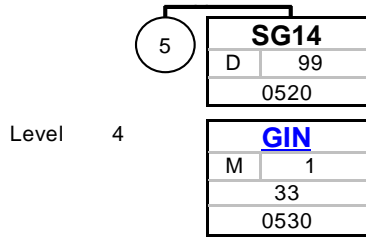

Tag
St MaxOcc
No
Counter

Tag = Segment/Group Tag
 St = Status (M=Mandatory, C=Conditional, R=Required, O=Optional, A=Advised, D=Dependent)
 MaxOcc = Maximum occurrence of the segment/group
 No = Consecutive segment number
 Counter = Counter of segment/group within the standard

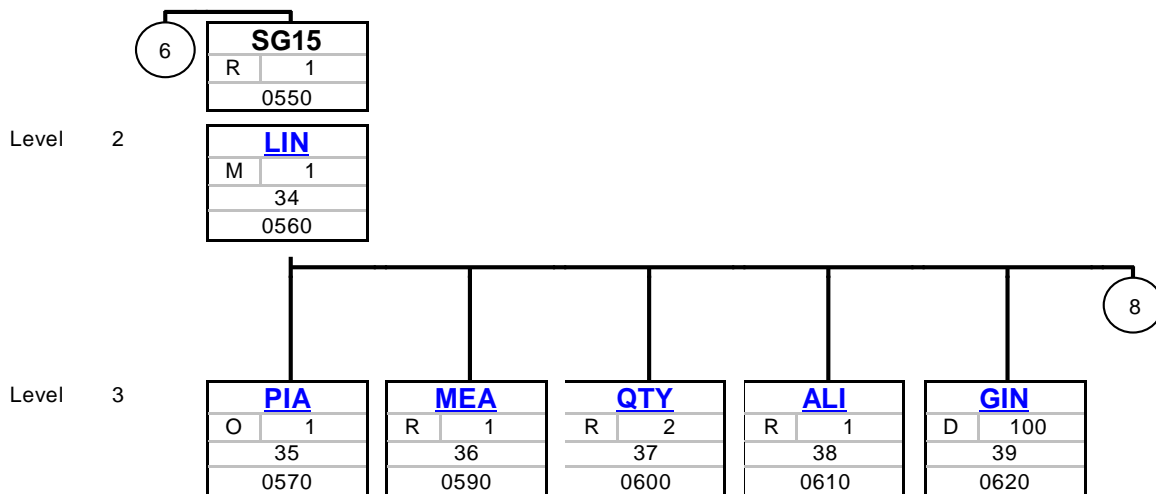

Tag
St MaxOcc
No
Counter

Tag = Segment/Group Tag
 St = Status (M=Mandatory, C=Conditional, R=Required, O=Optional, A=Advised, D=Dependent)
 MaxOcc = Maximum occurrence of the segment/group
 No = Consecutive segment number
 Counter = Counter of segment/group within the standard

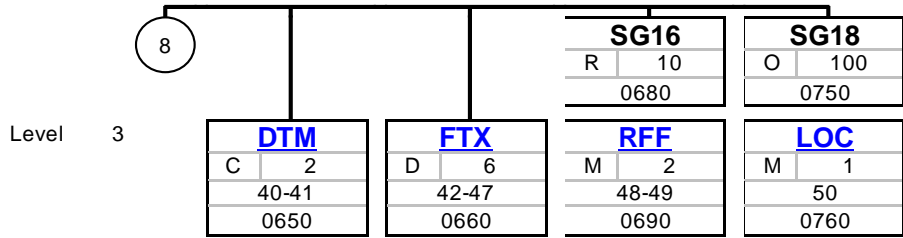

Tag
St MaxOcc
No
Counter

Tag = Segment/Group Tag
 St = Status (M=Mandatory, C=Conditional, R=Required, O=Optional, A=Advised, D=Dependent)
 MaxOcc = Maximum occurrence of the segment/group
 No = Consecutive segment number
 Counter = Counter of segment/group within the standard

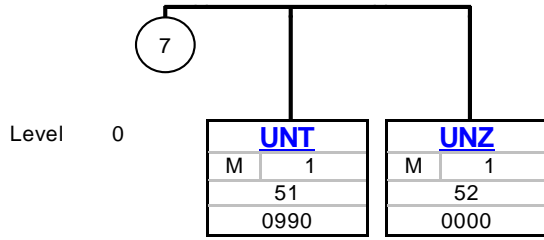

Tag
St MaxOcc
No
Counter

Tag = Segment/Group Tag
 St = Status (M=Mandatory, C=Conditional, R=Required, O=Optional, A=Advised, D=Dependent)
 MaxOcc = Maximum occurrence of the segment/group
 No = Consecutive segment number
 Counter = Counter of segment/group within the standard

Counter	No	Tag	St	MaxOcc	Level	Name
0000	2	UNB	M	1	0	INTERCHANGE HEADER

Standard			Implementation	
Tag	Name	St Format	St Format	Usage / Remark
UNB				
S001	SYNTAX IDENTIFIER	M	M	
0001	Syntax identifier	M a4	M a4	UNOA UNECE level A
0002	Syntax version number	M n1	M n1	Syntax version has to be "1"
S002	INTERCHANGE SENDER	M	M	
0004	Sender identification	M an..35	M an..35	
S003	INTERCHANGE RECIPIENT	M	M	
0010	Recipient identification	M an..35	M an..35	A complete list of UNB recipients may be obtained from edi.hotline@t-systems.com
S004	DATE/TIME OF PREPARATION	M	M	
0017	Date of preparation	M n6	M n6	
0019	Time of preparation	M n4	M n4	
0020	Interchange control reference	M an..14	M an..14	

Remark:
DE0026 must not be used.

Example:
UNB+UNOA:1+00013005499AOHH-SGM+OMERCEDES BENZSA+070930:2205+1614'

No = Consecutive segment number
MaxOcc = Maximum occurrence of the segment/group
Counter = Counter of segment/group within the standard

St = Status
EDIFACT: M=Mandatory, C=Conditional
User specific: R=Required, O=Optional, D=Dependent,
A=Advised, N=Not used

Counter	No	Tag	St	MaxOcc	Level	Name
0010	3	UNH	M	1	0	MESSAGE HEADER

		Standard	Implementation		
Tag	Name	St Format	St Format	Usage / Remark	
UNH					
0062	Message reference number	M an..14	M an..14		
S009	MESSAGE IDENTIFIER	M	M		
0065	Message type identifier	M an..6	M an..6	DESADV Despatch advice message	
0052	Message type version number	M an..3	M an..3	D Draft directory	
0054	Message type release number	M an..3	M an..3	96A Version 96A	
0051	Controlling agency	M an..2	M an..2	UN UN/ECE/TRADE/WP.4, United Nations Standard Messages (UNSM)	

Remark:

DE0057 must not be filled.

Example:

UNH+1+DESADV:D:96A:UN'

No = Consecutive segment number
 MaxOcc = Maximum occurrence of the segment/group
 Counter = Counter of segment/group within the standard

St = Status
 EDIFACT: M=Mandatory, C=Conditional
 User specific: R=Required, O=Optional, D=Dependent,
 A=Advised, N=Not used

Counter	No	Tag	St	MaxOcc	Level	Name
---------	----	-----	----	--------	-------	------

0020 4 **BGM** M 1 0 Beginning of message

Standard			Implementation	
Tag	Name	St Format	St Format	Usage / Remark
BGM				
C002	Document/message name	C	R	
1001	Document/message name, coded	C an..3	R n3	351 Despatch advice
1004	Document/message number	C an..35	R n..8	Despatch advice number Remark for VDA users: VDA4913, 713_03
1225	Message function, coded	C an..3	D an..3	H Cross Trade Kind of delivery " " Standard, "H" cross trade

Remark:

Example:

BGM+351+2967+H'

No = Consecutive segment number
 MaxOcc = Maximum occurrence of the segment/group
 Counter = Counter of segment/group within the standard

St = Status
 EDIFACT: M=Mandatory, C=Conditional
 User specific: R=Required, O=Optional, D=Dependent,
 A=Advised, N=Not used

Counter	No	Tag	St	MaxOcc	Level	Name
---------	----	-----	----	--------	-------	------

0030 5 **DTM** R 3 1 DTM

Standard			Implementation	
Tag	Name	St Format	St Format	Usage / Remark
DTM				
C507	Date/time/period	M	M	
2005	Date/time/period qualifier	M an..3	M an..3	11 Despatch date and or time
2380	Date/time/period	C an..35	R an..12	Remark for VDA users: VDA4913 713_04, shipping date (digits 3-8) 712_06, date of transfer to freight carrier (digits 3-8) 712_07, time of transfer to freight carrier (digits 9-12)
2379	Date/time/period format qualifier	C an..3	R an..3	203 CCYYMMDDHHMM

Remark:

Example:

DTM+11:20070930221700:203'

No = Consecutive segment number
 MaxOcc = Maximum occurrence of the segment/group
 Counter = Counter of segment/group within the standard

St = Status
 EDIFACT: M=Mandatory, C=Conditional
 User specific: R=Required, O=Optional, D=Dependent,
 A=Advised, N=Not used

Counter	No	Tag	St	MaxOcc	Level	Name
0030	6	DTM	R	3	1	DTM

Standard			Implementation	
Tag	Name	St Format	St Format	Usage / Remark
DTM				
C507	Date/time/period	M	M	
2005	Date/time/period qualifier	M an..3	M an..3	132 Arrival date/time, estimated
2380	Date/time/period	C an..35	R an..12	Remark for VDA users: VDA4913 712_18, estimated date of arrival (digits 3-8) 712_19, estimated time of arrival (digits 9-12)
2379	Date/time/period format qualifier	C an..3	R an..3	203 CCYYMMDDHHMM

Remark: required since 2016.12.

Example:

DTM+132:200710021700:203'

No = Consecutive segment number
 MaxOcc = Maximum occurrence of the segment/group
 Counter = Counter of segment/group within the standard

St = Status
 EDIFACT: M=Mandatory, C=Conditional
 User specific: R=Required, O=Optional, D=Dependent,
 A=Advised, N=Not used

Counter	No	Tag	St	MaxOcc	Level	Name
0030	7	DTM	R	3	1	DTM

		Standard	Implementation	
Tag	Name	St Format	St Format	Usage / Remark
DTM				
C507	Date/time/period	M	M	
2005	Date/time/period qualifier	M an..3	M an..3	137 Document/message date/time
2380	Date/time/period	C an..35	R an..12	Delivery note date / transmission date Remark for VDA users: VDA4913, 711_07, date of transmission (digits 3-8)
2379	Date/time/period format qualifier	C an..3	R an..3	203 CCYYMMDDHHMM

Remark:

Example:

DTM+137:20070930222200:203'

No = Consecutive segment number
 MaxOcc = Maximum occurrence of the segment/group
 Counter = Counter of segment/group within the standard

St = Status
 EDIFACT: M=Mandatory, C=Conditional
 User specific: R=Required, O=Optional, D=Dependent,
 A=Advised, N=Not used

Counter	No	Tag	St	MaxOcc	Level	Name
---------	----	-----	----	--------	-------	------

0050 8 **MEA** R 3 1 MEA

		Standard	Implementation	
Tag	Name	St Format	St Format	Usage / Remark
MEA				
6311	Measurement application qualifier	M an..3	M an..3	AAX Consignment measurement
C502	Measurement details	C	R	
6313	Measurement dimension, coded	C an..3	R an..3	AAD Total gross weight
C174	Value/range	C	R	
6411	Measure unit qualifier	M an..3	M an..3	KGM kilogram
6314	Measurement value	C n..18	R n..10(7.3)	Weight of goods including packing and / or auxiliary means of loading (i.e. pallets), but excluding carriers' receptacle (information from consignment note) Remark for VDA users: VDA4913, 712_08, consignments' gross weight

Remark: The weight can be maximal 10 digits from which 3 digits are reserved for decimal places, which are optional (the decimal dot/comma does not count to the length).

Example:

MEA+AAX+AAD+KGM:2046'
MEA+AAX+AAD+KGM:2046.123'

No = Consecutive segment number
MaxOcc = Maximum occurrence of the segment/group
Counter = Counter of segment/group within the standard

St = Status
EDIFACT: M=Mandatory, C=Conditional
User specific: R=Required, O=Optional, D=Dependent,
A=Advised, N=Not used

Counter	No	Tag	St	MaxOcc	Level	Name
---------	----	-----	----	--------	-------	------

0050 9 **MEA** O 3 1 MEA

		Standard	Implementation	
Tag	Name	St Format	St Format	Usage / Remark
MEA				
6311	Measurement application qualifier	M an..3	M an..3	AAX Consignment measurement
C502	Measurement details	C	R	
6313	Measurement dimension, coded	C an..3	R an..3	AAL Net weight
C174	Value/range	C	R	
6411	Measure unit qualifier	M an..3	M an..3	KGM kilogram
6314	Measurement value	C n..18	R n..10(7.3)	Weight of goods including packing, but excluding auxiliary means of loading (i.e. pallets) and carriers' receptacle Remark for VDA users: VDA4913, 712_09, consignments' net weight

Remark: The weight can be maximal 10 digits from which 3 digits are reserved for decimal places, which are optional (the decimal dot/comma does not count to the length).

Example:

MEA+AAX+AAL+KGM:1510'

No = Consecutive segment number
 MaxOcc = Maximum occurrence of the segment/group
 Counter = Counter of segment/group within the standard

St = Status
 EDIFACT: M=Mandatory, C=Conditional
 User specific: R=Required, O=Optional, D=Dependent,
 A=Advised, N=Not used

Counter	No	Tag	St	MaxOcc	Level	Name
---------	----	-----	----	--------	-------	------

0050 10 **MEA** O 3 1 MEA

Standard			Implementation	
Tag	Name	St Format	St Format	Usage / Remark
MEA				
6311	Measurement application qualifier	M an..3	M an..3	LMT Loading meters
C174	Value/range	C	R	
6411	Measure unit qualifier	M an..3	M an..3	MTR metre
6314	Measurement value	C n..18	R n..3(2.1)	Used space in meters Remark for VDA users: VDA4913, 712_20, used space in meters

Remark: The length can be maximal 3 digits from which 1 digit is reserved for decimal places, which is optional (the decimal dot/comma does not count to the length).

Example:

MEA+LMT++MTR:2'
MEA+LMT++MTR:25.1'

No = Consecutive segment number
MaxOcc = Maximum occurrence of the segment/group
Counter = Counter of segment/group within the standard

St = Status
EDIFACT: M=Mandatory, C=Conditional
User specific: R=Required, O=Optional, D=Dependent,
A=Advised, N=Not used

Counter	No	Tag	St	MaxOcc	Level	Name
0070		SG1	O	3	1	RFF
0080	11	RFF	M	1	1	Reference

Standard			Implementation	
Tag	Name	St Format	St Format	Usage / Remark
RFF				
C506	Reference	M	M	
1153	Reference qualifier	M an..3	M an..3	INN Interchange number new
1154	Reference number	C an..35	O n..5	Remark for VDA users: VDA4913, 711_06, transmission number, new

Remark: currently not used.

Example:
RFF+INN: 6'

No = Consecutive segment number
 MaxOcc = Maximum occurrence of the segment/group
 Counter = Counter of segment/group within the standard

St = Status
 EDIFACT: M=Mandatory, C=Conditional
 User specific: R=Required, O=Optional, D=Dependent,
 A=Advised, N=Not used

Counter	No	Tag	St	MaxOcc	Level	Name
0070		SG1	D	3	1	RFF-DTM
0090	12	DTM	O	1	2	Date/time/period

Standard			Implementation	
Tag	Name	St Format	St Format	Usage / Remark
DTM				
C507	Date/time/period	M	M	
2005	Date/time/period qualifier	M an..3	M an..3	171 Reference date/time
2380	Date/time/period	C an..35	C an..35	
2379	Date/time/period format qualifier	C an..3	R an..3	102 CCYYMMDD

Remark: currently not used.

Example:

DTM+171:20071010:102'

No = Consecutive segment number
 MaxOcc = Maximum occurrence of the segment/group
 Counter = Counter of segment/group within the standard

St = Status
 EDIFACT: M=Mandatory, C=Conditional
 User specific: R=Required, O=Optional, D=Dependent,
 A=Advised, N=Not used

Counter	No	Tag	St	MaxOcc	Level	Name
0070		SG1	O	3	1	RFF
0080	13	RFF	M	1	1	Reference

Standard			Implementation	
Tag	Name	St Format	St Format	Usage / Remark
RFF				
C506	Reference	M	M	
1153	Reference qualifier	M an..3	M an..3	INO Interchange number old
1154	Reference number	C an..35	O n..5	Remark for VDA users: VDA4913, 711_05, transmission number, old

Remark: currently not used.

Example:
RFF+INO:5'

No = Consecutive segment number
 MaxOcc = Maximum occurrence of the segment/group
 Counter = Counter of segment/group within the standard

St = Status
 EDIFACT: M=Mandatory, C=Conditional
 User specific: R=Required, O=Optional, D=Dependent,
 A=Advised, N=Not used

Counter	No	Tag	St	MaxOcc	Level	Name
0070		SG1	R	3	1	RFF
0080	14	RFF	M	1	1	Reference

Standard			Implementation	
Tag	Name	St Format	St Format	Usage / Remark
RFF				
C506	Reference	M	M	
1153	Reference qualifier	M an..3	M an..3	CRN Conveyance reference number
1154	Reference number	C an..35	R n..8	Consignment reference number must be unique within one year. All delivery notes referring to one consignment number are to be transferred sequently in one transmission. Remark for VDA users: VDA4913, 712_03, consignment number

Remark: You can choose a number you like, but please summarize all delivery notes for one unloading point under one CRN (SLB). This number may not be repeated within a calendar year. Suggestion: Use the Delivery note number.

Example:

RFF+CRN:2967'

No = Consecutive segment number
 MaxOcc = Maximum occurrence of the segment/group
 Counter = Counter of segment/group within the standard

St = Status
 EDIFACT: M=Mandatory, C=Conditional
 User specific: R=Required, O=Optional, D=Dependent,
 A=Advised, N=Not used

Counter	No	Tag	St	MaxOcc	Level	Name
0070		SG1	O	3	1	RFF
0080	14	RFF	M	1	1	Reference

Standard			Implementation	
Tag	Name	St Format	St Format	Usage / Remark
RFF				
C506	Reference	M	M	
1153	Reference qualifier	M an..3	M an..3	ACE Related document number
1154	Reference number	C an..35	R an..14	Remark for VDA users: VDA4913, 713_20, document number or PUS number

Remark:

Example:

RFF+ACE:0123456'

No = Consecutive segment number
 MaxOcc = Maximum occurrence of the segment/group
 Counter = Counter of segment/group within the standard

St = Status
 EDIFACT: M=Mandatory, C=Conditional
 User specific: R=Required, O=Optional, D=Dependent,
 A=Advised, N=Not used

Counter	No	Tag	St	MaxOcc	Level	Name
0100		SG2	R	7	1	NAD
0110	15	NAD	M	1	1	Name and address

Standard			Implementation	
Tag	Name	St Format	St Format	Usage / Remark
NAD				
3035	Party qualifier	M an..3	M an..3	BY Buyer
C082	Party identification details	C	R	
3039	Party id. identification	M an..35	M an..9	customer number Remark for VDA users: VDA4913, 711_03, data recipient
3055	Code list responsible agency, coded	C an..3	O an..3	91 Assigned by seller or seller's agent

Remark:

If not present then „LEER“ will be used as Buyer’s Party identification

Example:

NAD+BY+79380465:::91'

No = Consecutive segment number
 MaxOcc = Maximum occurrence of the segment/group
 Counter = Counter of segment/group within the standard

St = Status
 EDIFACT: M=Mandatory, C=Conditional
 User specific: R=Required, O=Optional, D=Dependent,
 A=Advised, N=Not used

Counter	No	Tag	St	MaxOcc	Level	Name
0100		SG2	R	7	1	NAD
0110	16	NAD	M	1	1	Name and address

Standard			Implementation	
Tag	Name	St Format	St Format	Usage / Remark
NAD				
3035	Party qualifier	M an..3	M an..3	CN Consignee
C082	Party identification details	C	R	
3039	Party id. identification	M an..35	M an..3	Mercedes Benz/Daimler Truck plant code Remark for VDA users: VDA4913, 713_11, data recipient
3055	Code list responsible agency, coded	C an..3	O an..3	92 Assigned by buyer or buyer's agent

Remark:

Example:

NAD+CN+571:::92'

No = Consecutive segment number
 MaxOcc = Maximum occurrence of the segment/group
 Counter = Counter of segment/group within the standard

St = Status
 EDIFACT: M=Mandatory, C=Conditional
 User specific: R=Required, O=Optional, D=Dependent,
 A=Advised, N=Not used

Counter	No	Tag	St	MaxOcc	Level	Name
0100		SG2	R	7	1	NAD-LOC
0120	17	LOC	R	10	2	Place/location identification

Standard			Implementation	
Tag	Name	St Format	St Format	Usage / Remark
LOC				
3227	Place/location qualifier	M an..3	M an..3	11 Place/port of discharge
C517	Location identification	C	R	
3224	Place/location	C an..70	R an..5	Place of unloading Remark for VDA users: VDA4913, 713_05, place of discharge

Remark:

C517.3225 can also be used to transmit the place of unloading.

Example:

LOC+11+:::516'

No = Consecutive segment number
 MaxOcc = Maximum occurrence of the segment/group
 Counter = Counter of segment/group within the standard

St = Status
 EDIFACT: M=Mandatory, C=Conditional
 User specific: R=Required, O=Optional, D=Dependent,
 A=Advised, N=Not used

Counter	No	Tag	St	MaxOcc	Level	Name
0160		SG4	R	10	2	CTA
0170	18	CTA	M	1	2	Contact information

Standard			Implementation	
Tag	Name	St Format	St Format	Usage / Remark
CTA				
3139	Contact function, coded	C an..3	R an..3	IC Information contact
C056	Department or employee details	C	R	
3412	Department or employee	C an..35	R an..4	Customers' sign (from LAB/DELINS/DELFOR) Remark for VDA users: VDA4913, 713_07, Customer's sign

Remark:

Example:

CTA+IC+: 63'

No = Consecutive segment number
 MaxOcc = Maximum occurrence of the segment/group
 Counter = Counter of segment/group within the standard

St = Status
 EDIFACT: M=Mandatory, C=Conditional
 User specific: R=Required, O=Optional, D=Dependent,
 A=Advised, N=Not used

Counter	No	Tag	St	MaxOcc	Level	Name
0100		SG2	D	7	1	NAD
0110	19	NAD	M	1	1	Name and address

Standard			Implementation	
Tag	Name	St Format	St Format	Usage / Remark
NAD				
3035	Party qualifier	M an..3	M an..3	VN Vendor
C082	Party identification details	C	R	
3039	Party id. identification	M an..35	M an..9	supplier's number Remark for VDA users: VDA4913, 713_16, data sender's number
3055	Code list responsible agency, coded	C an..3	O an..3	92 Assigned by buyer or buyer's agent

Remark:

This segment is only to be sent, if it is a delivery advice (i.e. transaction type 40 in VDA4913).

Remark for VDA users:
VDA4913, 713_09 = "40".

Example:

NAD+VN+15423205:::92'

No = Consecutive segment number
MaxOcc = Maximum occurrence of the segment/group
Counter = Counter of segment/group within the standard

St = Status
EDIFACT: M=Mandatory, C=Conditional
User specific: R=Required, O=Optional, D=Dependent,
A=Advised, N=Not used

Counter	No	Tag	St	MaxOcc	Level	Name
0100		SG2	D	7	1	LOC
0120	20	LOC	R	10	2	Place/location identification

Standard			Implementation	
Tag	Name	St Format	St Format	Usage / Remark
LOC				
3227	Place/location qualifier	M an..3	M an..3	92 Routing

Remark:

This segment is only to be sent, if it is a delivery advice (i.e. transaction type 40 in VDA4913).
 Remark for VDA users: VDA4913, 713_09 = "40".

Example:

LOC+92'

No = Consecutive segment number
 MaxOcc = Maximum occurrence of the segment/group
 Counter = Counter of segment/group within the standard

St = Status
 EDIFACT: M=Mandatory, C=Conditional
 User specific: R=Required, O=Optional, D=Dependent,
 A=Advised, N=Not used

Counter	No	Tag	St	MaxOcc	Level	Name
0100		SG2	O	7	1	NAD
0110	21	NAD	M	1	1	Name and address

Standard			Implementation	
Tag	Name	St Format	St Format	Usage / Remark
NAD				
3035	Party qualifier	M an..3	M an..3	CZ Consignor
C082	Party identification details	C	R	
3039	Party id. identification	M an..35	M an..3	supplier's plant Remark for VDA users: VDA4913, 712_04, supplier's plant
3055	Code list responsible agency, coded	C an..3	O an..3	92 Assigned by buyer or buyer's agent

Remark:

Example:

NAD+CZ+FFJ:::92'

No = Consecutive segment number
 MaxOcc = Maximum occurrence of the segment/group
 Counter = Counter of segment/group within the standard

St = Status
 EDIFACT: M=Mandatory, C=Conditional
 User specific: R=Required, O=Optional, D=Dependent,
 A=Advised, N=Not used

Counter	No	Tag	St	MaxOcc	Level	Name
0100		SG2	R	7	1	NAD
0110	22	NAD	M	1	1	Name and address

Standard			Implementation	
Tag	Name	St Format	St Format	Usage / Remark
NAD				
3035	Party qualifier	M an..3	M an..3	FW Freight forwarder
C082	Party identification details	C	R	
3039	Party id. identification	M an..35	M an..14	Freight Forwarder Remark for VDA users: VDA4913, 712_05, Freight Forwarder
3055	Code list responsible agency, coded	C an..3	O an..3	92 Assigned by buyer or buyer's agent

Remark:

Example:

NAD+FW+DUVENBECK:::92'

No = Consecutive segment number
 MaxOcc = Maximum occurrence of the segment/group
 Counter = Counter of segment/group within the standard

St = Status
 EDIFACT: M=Mandatory, C=Conditional
 User specific: R=Required, O=Optional, D=Dependent,
 A=Advised, N=Not used

Counter	No	Tag	St	MaxOcc	Level	Name
0100		SG2	R	7	1	NAD
0110	23	NAD	M	1	1	Name and address

Standard			Implementation	
Tag	Name	St Format	St Format	Usage / Remark
NAD				
3035	Party qualifier	M an..3	M an..3	SE Seller
C082	Party identification details	C	R	
3039	Party id. identification	M an..35	M an..9	supplier's number Remark for VDA users: VDA4913, 711_04, data sender's number
3055	Code list responsible agency, coded	C an..3	O an..3	92 Assigned by buyer or buyer's agent

Remark:

Example:

NAD+SE+15423205:::92'

No = Consecutive segment number
 MaxOcc = Maximum occurrence of the segment/group
 Counter = Counter of segment/group within the standard

St = Status
 EDIFACT: M=Mandatory, C=Conditional
 User specific: R=Required, O=Optional, D=Dependent,
 A=Advised, N=Not used

Counter	No	Tag	St	MaxOcc	Level	Name
0100		SG2	D	7	1	NAD
0110	24	NAD	M	1	1	Name and address

Standard			Implementation	
Tag	Name	St Format	St Format	Usage / Remark
NAD				
3035	Party qualifier	M an..3	M an..3	DP Delivery party
C082	Party identification details	C	R	
3039	Party id. identification	M an..35	M an..9	consignee's number Remark for VDA users: VDA4913, 713_13, data sender's number
3055	Code list responsible agency, coded	C an..3	O an..3	92 Assigned by buyer or buyer's agent

Remark:
This segment is only to be sent in case of cross trade.

Example:
NAD+DP+16117186:::92'

No = Consecutive segment number
MaxOcc = Maximum occurrence of the segment/group
Counter = Counter of segment/group within the standard

St = Status
EDIFACT: M=Mandatory, C=Conditional
User specific: R=Required, O=Optional, D=Dependent,
A=Advised, N=Not used

Counter	No	Tag	St	MaxOcc	Level	Name
0190		SG5	R	10	1	TOD
0200	25	TOD	M	1	1	Terms of delivery or transport

Standard			Implementation	
Tag	Name	St Format	St Format	Usage / Remark
TOD				
C100	Terms of delivery or transport	C	R	
4053	Terms of delivery or transport, coded	C an..3	R an..3	Incoterms Remark for VDA users: VDA4913, 712_10, freight terms EXW Ex works CIP Freight, Carriage, Insurance to destination DAF Delivery at frontier - Named place DAP Delivered at Place DDP Delivered duty paid to destination FCA Free carrier - Named point 99 Individual agreement
3055	Code list responsible agency, coded	C an..3	O an..3	4 ICC (International Chamber of Commerce)

Remark:

Example:

TOD+++EXW: : 4'

No = Consecutive segment number
 MaxOcc = Maximum occurrence of the segment/group
 Counter = Counter of segment/group within the standard

St = Status
 EDIFACT: M=Mandatory, C=Conditional
 User specific: R=Required, O=Optional, D=Dependent,
 A=Advised, N=Not used

Counter	No	Tag	St	MaxOcc	Level	Name
0230		SG6	R	10	1	TDT
0240	26	TDT	M	1	1	Details of transport

Standard			Implementation	
Tag	Name	St Format	St Format	Usage / Remark
TDT				
8051	Transport stage qualifier	M an..3	M an..3	12 At departure
C220	Mode of transport	C	R	
8067	Mode of transport, coded	C an..3	R an..2	type of dispatch 10 Maritime transport 20 Rail transport 30 Road transport 40 Air transport 50 Mail 01 Truck (sub supplier) 02 Truck (customer) 04 Truck (railway) 05 Truck own (supplier) 07 Rail Express 08 Rail Waggon 5 Parcel Service Remark for VDA users: VDA4913, 713_06, type of dispatch
C228	Transport means	C	R	
8179	Type of means of transport identification	C an..8	R an..2	Means of transportation, code 02 loading list number / bordereau-number 06 single dispatch item number 07 express parcel number 08 railway car number 09 post parcel number 10 airwaybill number / flight number 11 vessel name 31 license number Remark for VDA users: VDA4913, 712_14
8178	Type of means of transport	C an..17	D an..17	Number of means of transportation. Only be used if C222.8213 = 1: Enter value according to C228.8179. If the number is not known, enter "9". = 2: Enter bordereau number VDA users: VDA4913, 712_15, number of means of transportation
C040	Carrier	C	O	
3127	Carrier identification	C an..17	O an..14	transportation partner number Remark for VDA users: VDA4913, 712_13, transp. partner number
C222	Transport identification	C	R	
8213	Id. of means of transport identification	C an..9	D an..1	"" (Empty) default value * 1 For postal code (zip code) ** 2 In case of bordereau. See C228.8179 and C228.8178 *** Remark for VDA users: VDA4913, 712_16, Qualifier for information in record 712, field 17
8212	Id. of means of transport	C An..35	R An..25	Number of means of transportation if C222.8213 = "": Enter value according to C228.8179. If the number is not known, enter "9". In the case of the license number, "LKW" (truck) can be used if the license number is not known. if C222.8213 = 1: Enter the postal code (zip code) of the address of the shipping plant. if C222.8213 = 2: Enter the registration number of the vehicle. If not known, then enter "LKW" (truck). Remark for VDA users: VDA4913, 712_15 / 712_17

Example: TDT+12++30+31+DUVENBECK+++::SI 690 AO' *

Example: TDT+12++30+31:SI 690 AO+DUVENBECK+++1::70372' **

Example: TDT+12++30+02:73202655+DUVENBECK+++2::SI 690 AO' ***

No = Consecutive segment number
 MaxOcc = Maximum occurrence of the segment/group
 Counter = Counter of segment/group within the standard

St = Status
 EDIFACT: M=Mandatory, C=Conditional
 User specific: R=Required, O=Optional, D=Dependent,
 A=Advised, N=Not used

Counter	No	Tag	St	MaxOcc	Level	Name
0370		SG10	R	9999	1	CPS
0380	27	CPS	M	1	1	Consignment packing sequence

Standard			Implementation	
Tag	Name	St Format	St Format	Usage / Remark
CPS				
7164	Hierarchical id. number	M an..12	M an..12	
7075	Packaging level, coded	C an..3	O an..3	1 Inner 3 Outer

Remark:

Every delivery note item is to be represented in a separate SG10 group.

There are two different types of packaging:

Inner packages are crates, boxes, etc. which can be palletized and in which products are delivered.

Outer packages are pallets and other loading equipment on which inner packages are loaded.

Example:

CPS+1++1'

No = Consecutive segment number
 MaxOcc = Maximum occurrence of the segment/group
 Counter = Counter of segment/group within the standard

St = Status
 EDIFACT: M=Mandatory, C=Conditional
 User specific: R=Required, O=Optional, D=Dependent,
 A=Advised, N=Not used

Counter	No	Tag	St	MaxOcc	Level	Name
0400		SG11	D	9999	2	CPS-PAC
0410	28	PAC	M	1	2	Package

Standard			Implementation	
Tag	Name	St Format	St Format	Usage / Remark
PAC				
7224	Number of packages	C n..8	R n..8	
C202	Package type	C	R	
7065	Type of packages identification	C an..17	R an..17	Mercedes Benz's/Daimler Trucks package type ID for boxes, etc. (S-label), and loading equipment as pallets (G/M-label) respectively Remark for VDA users: VDA4913, 715_03
3055	Code list responsible agency, coded	C an..3	O an..3	92 Assigned by buyer or buyer's agent

Remark:

Following dependencies are valid:

An inner packaging (CPS_7075=1) is always followed by a SG13-PCI-segment with "S" and a SG13-GIR-segment.

An outer packaging (CPS_7075=3) is always followed by a SG13-PCI-segment with "G" or "M" and a SG14-GIN-segment.

In case of packaging (packaging aid) without any label the SG13-PCI-segment does not apply.

Example:

PAC+1++2032: :92'

No = Consecutive segment number
 MaxOcc = Maximum occurrence of the segment/group
 Counter = Counter of segment/group within the standard

St = Status
 EDIFACT: M=Mandatory, C=Conditional
 User specific: R=Required, O=Optional, D=Dependent,
 A=Advised, N=Not used

Counter	No	Tag	St	MaxOcc	Level	Name
0400		SG11	D	9999	2	CPS-PAC-MEA
0420	29	MEA	O	3	3	Measurements

Standard			Implementation	
Tag	Name	St Format	St Format	Usage / Remark
MEA				
6311	Measurement application qualifier	M an..3	M an..3	AAY Package measurement
C502	Measurement details	C	R	
6313	Measurement dimension, coded	C an..3	R an..3	HT Height dimension LN Length dimension WD Width
C174	Value/range	C	R	
6411	Measure unit qualifier	M an..3	R an..3	DAY day GRM gram HUR hour KGM kilogram KTM kilometre LTR litre MMT millimetre MTK square metre MTQ cubic metre MTR metre PCE piece PR pair SET set TNE metric ton EA each PK package
6314	Measurement value	C n..18	R n..4	

Remark: Remark for VDA users: VDA4913, 715_10

Example:

MEA+AAY+HT+MMT:600'
 MEA+AAY+LN+MMT:1600'
 MEA+AAY+WD+MMT:60'

No = Consecutive segment number
 MaxOcc = Maximum occurrence of the segment/group
 Counter = Counter of segment/group within the standard

St = Status
 EDIFACT: M=Mandatory, C=Conditional
 User specific: R=Required, O=Optional, D=Dependent,
 A=Advised, N=Not used

Counter	No	Tag	St	MaxOcc	Level	Name
0400		SG11	D	9999	2	CPS-PAC-MEA-QTY
0430	30	QTY	D	1	3	Quantity

Standard			Implementation	
Tag	Name	St Format	St Format	Usage / Remark
QTY				
C186	Quantity details	M	M	
6063	Quantity qualifier	M an..3	M an..3	52 Quantity per pack 189 Number of packages in handling unit
6060	Quantity	M n..15	M n..13(10.3)	Remark for VDA users: VDA4913, 715_07
6411	Measure unit qualifier	C an..3	D an..3	DAY day PCE Piece EA each GRM gram HUR hour KGM kilogram KTM kilometre LTR litre MMT millimetre MTK square metre MTQ cubic metre MTR metre PCE Piece PR pair SET set TNE metric ton EA each PK package

Remark: The quantity can be maximal 13 digits from which 3 digits are reserved for decimal places, which are optional (the decimal dot/comma does not count to the length).

Please do not send QTY+52 and QTY+189 together!

Example:

QTY+52:200:PCE'

No = Consecutive segment number
 MaxOcc = Maximum occurrence of the segment/group
 Counter = Counter of segment/group within the standard

St = Status
 EDIFACT: M=Mandatory, C=Conditional
 User specific: R=Required, O=Optional, D=Dependent,
 A=Advised, N=Not used

Counter	No	Tag	St	MaxOcc	Level	Name
0470		SG13	D	1000	3	CPS-PAC-PCI-GIR
0480	31	PCI	M	1	3	Package identification

Standard			Implementation	
Tag	Name	St Format	St Format	Usage / Remark
PCI				
4233	Marking instructions, coded	C an..3	R an..3	17 Seller's instructions
C827	Type of marking	C	R	
7511	Type of marking, coded	M an..3	M an..3	S single label G mixed package (with subpackages and different article numbers) M master label (with subpackages and same article numbers) Remark for VDA users: VDA4913, 715_13
3055	Code list responsible agency, coded	C an..3	O an..3	10 OJETTE

Remark:
in case of packaging without label the SG13-PCI-segment does not apply

Example:
PCI+17+++S::10'

No = Consecutive segment number
 MaxOcc = Maximum occurrence of the segment/group
 Counter = Counter of segment/group within the standard

St = Status
 EDIFACT: M=Mandatory, C=Conditional
 User specific: R=Required, O=Optional, D=Dependent,
 A=Advised, N=Not used

Counter	No	Tag	St	MaxOcc	Level	Name
0470		SG13	D	1000	3	CPS-PAC-PCI-GIR
0510	32	GIR	D	99	4	Related identification numbers

Standard			Implementation	
Tag	Name	St Format	St Format	Usage / Remark
GIR				
7297	Set identification qualifier	M an..3	M an..3	3 Package
C206	Identification number	M	M	
7402	Identity number	M an..35	M an..9	Remark for VDA users: VDA4913, 715_08
7405	Identity number qualifier	C an..3	C an..3	ML Marking/label number

Remark: For inner handling unit IDs.

Example:

GIR+3+31244:ML'

No = Consecutive segment number
 MaxOcc = Maximum occurrence of the segment/group
 Counter = Counter of segment/group within the standard

St = Status
 EDIFACT: M=Mandatory, C=Conditional
 User specific: R=Required, O=Optional, D=Dependent,
 A=Advised, N=Not used

Counter	No	Tag	St	MaxOcc	Level	Name
0520		SG14	D	99	4	CPS-PAC-PCI-GIN
0530	33	GIN	M	1	4	Goods identity number

Standard			Implementation	
Tag	Name	St Format	St Format	Usage / Remark
GIN				
7405	Identity number qualifier	M an..3	M an..3	ML Marking/label number
C208	Identity number range	M	M	
7402	Identity number	M an..35	M an..9	Remark for VDA users: VDA4913, 715_08

Remark:

For each outer handling unit ID a separate SG11-PAC-SG13-PCI-SG14-GIN-group must be transferred.

Example:

GIN+ML+5560'

No = Consecutive segment number
 MaxOcc = Maximum occurrence of the segment/group
 Counter = Counter of segment/group within the standard

St = Status
 EDIFACT: M=Mandatory, C=Conditional
 User specific: R=Required, O=Optional, D=Dependent,
 A=Advised, N=Not used

Counter	No	Tag	St	MaxOcc	Level	Name
0550		SG15	R	1	2	CPS-LIN
0560	34	LIN	M	1	2	Line item

Standard			Implementation	
Tag	Name	St Format	St Format	Usage / Remark
LIN				
1082	Line item number	C n..6	R n..3	delivery note item number Remark for VDA users: VDA4913, 714_12, item delivery note
C212	Item number identification	C	R	
7140	Item number	C an..35	R an..22	Mercedes Benz/Daimler Truck article number Remark for VDA users: VDA4913, 714_03, article number customer
7143	Item number type, coded	C an..3	O an..3	IN Buyer's item number

Remark:

For each CPS segment only one LIN group should be used to make sure, that all packaging is clearly assigned to one article number. (Imitating VDA logic)

Example:

LIN+1++A6396711220:IN'

No = Consecutive segment number
 MaxOcc = Maximum occurrence of the segment/group
 Counter = Counter of segment/group within the standard

St = Status
 EDIFACT: M=Mandatory, C=Conditional
 User specific: R=Required, O=Optional, D=Dependent,
 A=Advised, N=Not used

Counter	No	Tag	St	MaxOcc	Level	Name
0550		SG15	R	1	2	CPS-LIN-PIA
0570	35	PIA	O	1	3	Additional product id

Standard			Implementation	
Tag	Name	St Format	St Format	Usage / Remark
PIA				
4347	Product id. function qualifier	M an..3	M an..3	1 Additional identification
C212	Item number identification	M	M	
7140	Item number	C an..35	O an..35	supplier's article number Remark for VDA users: VDA4913, 714_04, article number supplier
7143	Item number type, coded	C an..3	O an..3	SA Supplier's article number
C212	Item number identification	C	O	
7140	Item number	C an..35	D an..35	Drawing geometry state Remark for VDA users: VDA4913, 714_21, code for changed construction VDA4913, 716_03
7143	Item number type, coded	C an..3	D an..3	DR Drawing revision number
C212	Item number identification	C	O	
7140	Item number	C an..35	O an..35	Remark for VDA users: VDA4913, 714_14, code for batch/chargen/ident number
7143	Item number type, coded	C an..3	O an..3	NB Batch number

Remark: The Drawing revision number is mandatory for MTC shipments.

Drawing geometry state = "Z" + DGS/ZGS + "Q" or "E" = Z001E

The length of DGS/ZGS is 3-digits

Q = Quality status

E = Development status

Example:

PIA+1+7990000345:SA+Z001E:DR+564575 CK:NB'

No = Consecutive segment number
 MaxOcc = Maximum occurrence of the segment/group
 Counter = Counter of segment/group within the standard

St = Status
 EDIFACT: M=Mandatory, C=Conditional
 User specific: R=Required, O=Optional, D=Dependent,
 A=Advised, N=Not used

Counter	No	Tag	St	MaxOcc	Level	Name
0550		SG15	R	1	2	CPS-LIN-PIA-MEA
0590	36	MEA	R	1	3	Measurements

Standard			Implementation	
Tag	Name	St Format	St Format	Usage / Remark
MEA				
6311	Measurement application qualifier	M an..3	M an..3	AAI Item weight
C502	Measurement details	C	C	
6313	Measurement dimension, coded	C an..3	C an..3	N Actual net weight
C174	Value/range	C	C	
6411	Measure unit qualifier	M an..3	M an..3	KGM Kilogram *
6314	Measurement value	C n..18	C n..18	kilogram net weight Remark for VDA users: VDA4913, 716_05

Remark:
The net weight of one item in Kilogram.

Example:
MEA+AAI+N+KGM:83.01'

No = Consecutive segment number
MaxOcc = Maximum occurrence of the segment/group
Counter = Counter of segment/group within the standard

St = Status
EDIFACT: M=Mandatory, C=Conditional
User specific: R=Required, O=Optional, D=Dependent,
A=Advised, N=Not used

Counter	No	Tag	St	MaxOcc	Level	Name
0550		SG15	R	1	2	CPS-LIN-PIA-MEA-QTY
0600	37	QTY	R	2	3	Quantity

Standard			Implementation	
Tag	Name	St Format	St Format	Usage / Remark
QTY				
C186	Quantity details	M	M	
6063	Quantity qualifier	M an..3	M an..3	12 Despatch quantity 21 Delivery quantity supplier (Dependent)
6060	Quantity	M n..15	M n..13(10.3)	Remark for VDA users: In case of QTY+12: 714_06, supplied quantity In case of QTY+21: 714_08, supplied quantity 2
6411	Measure unit qualifier	C an..3	R an..3	Remark for VDA users: VDA4913, 714_07/714_09, measure unit DAY day PCE Piece EA each GRM gram HUR hour KGM kilogram KTM kilometre LTR litre MMT millimetre MTK square metre MTQ cubic metre MTR metre PCE Piece PR pair SET set TNE metric ton EA each PK package

Remark: The quantity can be maximal 13 digits from which 3 digits are reserved for decimal places, which are optional (the decimal dot/comma does not count to the length).

Example:

QTY+12:200:PCE'
QTY+21:200:PCE'

No = Consecutive segment number
MaxOcc = Maximum occurrence of the segment/group
Counter = Counter of segment/group within the standard

St = Status
EDIFACT: M=Mandatory, C=Conditional
User specific: R=Required, O=Optional, D=Dependent,
A=Advised, N=Not used

Counter	No	Tag	St	MaxOcc	Level	Name
0550		SG15	R	1	2	CPS-LIN-PIA-MEA-QTY-ALI
0610	38	ALI	R	1	3	Additional information

Standard			Implementation	
Tag	Name	St Format	St Format	Usage / Remark
ALI				
3239	Country of origin, coded	C an..3	R an..3	different country qualifiers possible Remark for VDA users: VDA4913, 714_05, country of origin
9213	Type of duty regime, coded	C an..3	R an..3	Remark for VDA users: VDA4913, 714_17, status of preference 1 Origin subject to EC/EFTA preference 2 Origin subject to other preference agreement 3 No preference origin
4183	Special condition, code	C an..3	D an..3	Remark for VDA users: VDA4913, 714_18, Dutiable goods indicator Y yes, goods are dutiable / subject to customs procedures N or empty = no, goods are not subject to customs procedures

Remark:

Example:

ALI+SK+1+N'

No = Consecutive segment number
 MaxOcc = Maximum occurrence of the segment/group
 Counter = Counter of segment/group within the standard

St = Status
 EDIFACT: M=Mandatory, C=Conditional
 User specific: R=Required, O=Optional, D=Dependent,
 A=Advised, N=Not used

Counter	No	Tag	St	MaxOcc	Level	Name
0550		SG15	R	1	2	CPS-LIN-PIA-MEA-QTY-ALI-GIN
0620	39	GIN	D	100	3	Goods identity number

Standard			Implementation	
Tag	Name	St Format	St Format	Usage / Remark
GIN				
7405	Identity number qualifier	M an..3	M an..3	BN Serial number
C208	Identity number range	M	R	
7402	Identity number	M an..35	M an..10	Remark for VDA users: VDA4913, 718_03...
C208	Identity number range	C	O	
7402	Identity number	M an..35	M an..10	
C208	Identity number range	C	C	
7402	Identity number	M an..35	M an..10	
C208	Identity number range	C	C	
7402	Identity number	M an..35	M an..10	
C208	Identity number range	C	C	
7402	Identity number	M an..35	M an..10	

Remark:

This segment only applies, if Mercedes Benz/Daimler Truck has sent the DELJIT message in advance, containing the production numbers.

Example:

GIN+BN+1495027+1495028+1495029+1495030+1495031'

No = Consecutive segment number
 MaxOcc = Maximum occurrence of the segment/group
 Counter = Counter of segment/group within the standard

St = Status
 EDIFACT: M=Mandatory, C=Conditional
 User specific: R=Required, O=Optional, D=Dependent,
 A=Advised, N=Not used

Counter	No	Tag	St	MaxOcc	Level	Name
0550		SG15	R	1	2	CPS-LIN-PIA-MEA-QTY-ALI-GIN-DTM
0650	40	DTM	C	5	3	Date

Standard			Implementation	
Tag	Name	St Format	St Format	Usage / Remark
DTM				
C507	Date/time/period	M	M	
2005	Date/time/period qualifier	M an..3	M an..3	36 Expiry date / Minimum Shelf Life
2380	Date/time/period	C an..35	C an..8	Remark for VDA users: VDA4913, 716_03
2379	Date/time/period format qualifier	C an..3	C an..3	102 CCYYMMDD

Remark:

Example:

DTM+36:20080930:102'

Counter	No	Tag	St	MaxOcc	Level	Name
0550		SG15	R	1	2	CPS-LIN-PIA-MEA-QTY-ALI-GIN-DTM
0650	41	DTM	D	5	3	Date

Standard			Implementation	
Tag	Name	St Format	St Format	Usage / Remark
DTM				
C507	Date/time/period	M	M	
2005	Date/time/period qualifier	M an..3	M an..3	222 Presentation date / Drawing date
2380	Date/time/period	C an..35	C an..8	Remark for VDA users: VDA4913, 716_05
2379	Date/time/period format qualifier	C an..3	C an..3	102 CCYYMMDD

Remark: For MTC shipments only.

Example:

DTM+202:20220209:102'

No = Consecutive segment number
 MaxOcc = Maximum occurrence of the segment/group
 Counter = Counter of segment/group within the standard

St = Status
 EDIFACT: M=Mandatory, C=Conditional
 User specific: R=Required, O=Optional, D=Dependent,
 A=Advised, N=Not used

Counter	No	Tag	St	MaxOcc	Level	Name
0550		SG15	R	1	2	CPS-LIN-PIA-MEA-QTY-ALI-GIN-DTM-FTX
0660	42	FTX	O	1	3	Free text

Standard			Implementation	
Tag	Name	St Format	St Format	Usage / Remark
FTX				
4451	Text subject qualifier	M an..3	M an..3	LIN Line item
C108	Text literal	C	O	
4440	Free text	M an..70	M an..70	Remark for VDA users: VDA4913, 716_03/04
4440	Free text	C an..70	O an..70	Remark for VDA users: VDA4913, 716_04

Remark:
Segment should not present if drawing geometry state is available in segment PIA.

Example:
FTX+LIN+++TEXT 1:TEXT 2'

Counter	No	Tag	St	MaxOcc	Level	Name
0550		SG15	R	1	2	CPS-LIN-PIA-MEA-QTY-ALI-GIN-DTM-FTX
0660	43	FTX	D	5	3	Free text

Standard			Implementation	
Tag	Name	St Format	St Format	Usage / Remark
FTX				
4451	Text subject qualifier	M an..3	M an..3	ACB Additional information
C108	Text literal	C	O	
4440.1	Free text	M an..70	M an..3	PPB = Pre-production test batch (optional) POP = Purchase order position VER = Version number FIN = Finas ID SID = Supplier ID (either FIN or SID but not both) PRJ = Project
4440.2	Free text	M an..70	O an..3 R an..3 R an..11 D an..26 D an..26 R an..10	Pre-production test batch (optional) Purchase order position for the respective delivery Version number as specified in the order under "Vers-Nr." Finas ID as specified in the purchase order Supplier ID Project as referenced in purchase order Remark for VDA users: VDA4913, 716

Remark: For MTC shipments only. One FTX+ACB for each information as shown below.

Example:
FTX+ACB+++PPB:125'
FTX+ACB+++POP:001'
FTX+ACB+++VER:A417'
FTX+ACB+++FIN:100000000001'
FTX+ACB+++PRJ:012345'

No = Consecutive segment number
MaxOcc = Maximum occurrence of the segment/group
Counter = Counter of segment/group within the standard

St = Status
EDIFACT: M=Mandatory, C=Conditional
User specific: R=Required, O=Optional, D=Dependent,
A=Advised, N=Not used

Counter	No	Tag	St	MaxOcc	Level	Name
0550		SG15	R	1	2	CPS-LIN-PIA-MEA-QTY-ALI-GIN-DTM-FTX
0660	44	FTX	D	1	3	Free text

Standard			Implementation	
Tag	Name	St Format	St Format	Usage / Remark
FTX				
4451	Text subject qualifier	M an..3	M an..3	AAI General information (notes text)
C108	Text literal	C	O	
4440	Free text	M an..70	M an..23	
Remark for VDA users: VDA4913, 716_05				

Remark: For MTC shipments only.

Example:

FTX+AAI+++Text'

Counter	No	Tag	St	MaxOcc	Level	Name
0550		SG15	R	1	2	CPS-LIN-PIA-MEA-QTY-ALI-GIN-DTM-FTX
0660	45	FTX	O	1	3	Free text

Standard			Implementation	
Tag	Name	St Format	St Format	Usage / Remark
FTX				
4451	Text subject qualifier	M an..3	M an..3	TAX VAT rate
C108	Text literal	C	O	
4440	Free text	M an..70	M an..3	
VAT rate Remark for VDA users: VDA4913, 714_10				

Remark: The decimal dot/comma does not count to the length.

Example:

FTX+TAX+++12.0'

No = Consecutive segment number
 MaxOcc = Maximum occurrence of the segment/group
 Counter = Counter of segment/group within the standard

St = Status
 EDIFACT: M=Mandatory, C=Conditional
 User specific: R=Required, O=Optional, D=Dependent,
 A=Advised, N=Not used

Counter	No	Tag	St	MaxOcc	Level	Name
0550		SG15	R	1	2	CPS-LIN-PIA-MEA-QTY-ALI-GIN-DTM-FTX
0660	46	FTX	O	1	3	Free text

Standard			Implementation	
Tag	Name	St Format	St Format	Usage / Remark
FTX				
4451	Text subject qualifier	M an..3	M an..3	ACF Additional attribute information
C108	Text literal	C	O	
4440	Free text	M an..70	M an..1	Usage code S = Series general E = Replacement general U = Series and replacement V = Test P = Pilot Z = Additional demand M = Initial sample Y = Sample X = Other Remark for VDA users: VDA4913, 714_15

Remark:

Example:

FTX+ACF+++S'

Counter	No	Tag	St	MaxOcc	Level	Name
0550		SG15	R	1	2	CPS-LIN-PIA-MEA-QTY-ALI-GIN-DTM-FTX
0660	47	FTX	D	1	3	Free text

Standard			Implementation	
Tag	Name	St Format	St Format	Usage / Remark
FTX				
4451	Text subject qualifier	M an..3	M an..3	CHG Engineering change notice
C108	Text literal	C	O	
4440	Free text	M an..70	M an..13	Indication of the engineering change notice specified in the purchase order under KEM (MTC) or as indicated in the drawing (plants) Remark for VDA users: VDA4913, 716_03

Remark: For MTC shipments only.

Example:

FTX+CHG+++KEM123054'

No = Consecutive segment number
 MaxOcc = Maximum occurrence of the segment/group
 Counter = Counter of segment/group within the standard

St = Status
 EDIFACT: M=Mandatory, C=Conditional
 User specific: R=Required, O=Optional, D=Dependent,
 A=Advised, N=Not used

Counter	No	Tag	St	MaxOcc	Level	Name
0680		SG16	R	10	3	CPS-LIN-PIA-MEA-QTY-ALI-GIN-DTM-FTX-RFF
0690	48	RFF	M	1	3	Reference

Standard			Implementation	
Tag	Name	St Format	St Format	Usage / Remark
RFF				
C506	Reference	M	M	
1153	Reference qualifier	M an..3	M an..3	ON Order number (purchase)
1154	Reference number	C an..35	C n..12	Mercedes Benz/Daimler Truck order number or number of a Mercedes Benz/Daimler Truck frame contract. Remark for VDA users: VDA4913, 713_08, Contract/order number
4000	Reference version number	C an..35	O an..1	Blank = normal delivery F = Daily call-off (according to VDA recommendation 4915) P = Production-synchronous call-off (according to VDA recommendation 4916). For "P", the assigned production numbers must be transmitted with record type 718 (See SG15-GIN). Remark for VDA users: VDA4913, 714_13 Type of call-off, coded

Remark: If the order number is not known a "9" should be entered.

Example:

RFF+ON:57170911C::P'

Counter	No	Tag	St	MaxOcc	Level	Name
0680		SG16	R	10	3	CPS-LIN-PIA-MEA-QTY-ALI-GIN-DTM-FTX-RFF
0690	49	RFF	D	1	3	Reference

Standard			Implementation	
Tag	Name	St Format	St Format	Usage / Remark
RFF				
C506	Reference	M	M	
1153	Reference qualifier	M an..3	M an..3	AEB sub-Assembly number
1154	Reference number	C an..35	C n..8	Indication of vehicle or sub-assembly number as specified in the purchase order under vehicle no. (Fzg-Nr.) /subassembly no. (Aggregate-Nr.) Remark for VDA users: VDA4913, 716_04

Remark: For MTC shipments only.

Example:

RFF+AEB:01234567'

No = Consecutive segment number
MaxOcc = Maximum occurrence of the segment/group
Counter = Counter of segment/group within the standard

St = Status
EDIFACT: M=Mandatory, C=Conditional
User specific: R=Required, O=Optional, D=Dependent,
A=Advised, N=Not used

Counter	No	Tag	St	MaxOcc	Level	Name
0750		SG18	O	100	3	CPS-LIN-PIA-MEA-QTY-ALI-GIN-DTM-FTX-RFF-LOC
0760	50	LOC	O	1	3	Place/location identification

Standard			Implementation	
Tag	Name	St Format	St Format	Usage / Remark
LOC				
3227	Place/location qualifier	M an..3	M an..3	159 Additional internal destination
C517	Location identification	C	O	
3224	Place/location	C an..70	O an..7	Remark for VDA users: VDA4913, 713_15, stock location

Remark:

Example:

LOC+159+:::22'

No = Consecutive segment number
 MaxOcc = Maximum occurrence of the segment/group
 Counter = Counter of segment/group within the standard

St = Status
 EDIFACT: M=Mandatory, C=Conditional
 User specific: R=Required, O=Optional, D=Dependent,
 A=Advised, N=Not used

Counter	No	Tag	St	MaxOcc	Level	Name
0990	51	UNT	M	1	0	MESSAGE TRAILER

		Standard	Implementation	
Tag	Name	St Format	St Format	Usage / Remark
UNT				
0074	Number of segments in a message	M n..6	M n..6	
0062	Message reference number	M an..14	M an..14	

Remark:

Example:

UNT+42+1'

No = Consecutive segment number
 MaxOcc = Maximum occurrence of the segment/group
 Counter = Counter of segment/group within the standard

St = Status
 EDIFACT: M=Mandatory, C=Conditional
 User specific: R=Required, O=Optional, D=Dependent,
 A=Advised, N=Not used

Counter	No	Tag	St	MaxOcc	Level	Name
0000	52	UNZ	M	1	0	INTERCHANGE TRAILER

Standard			Implementation	
Tag	Name	St Format	St Format	Usage / Remark
UNZ				
0036	Interchange control count	M n..6	M n..6	
0020	Interchange control reference	M an..14	M an..14	

Remark:

Example:
UNZ+1+1614'

Packaging structure examples for EDIFACT DESADV D:96A

Example 1a, (3 boxes, same part number)

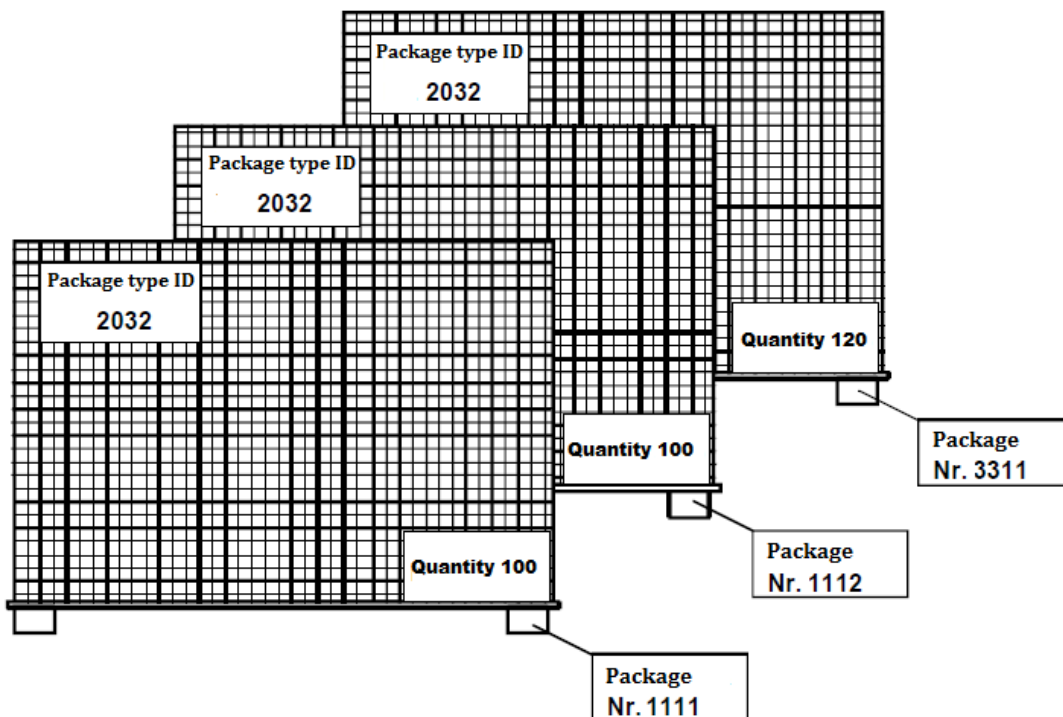

EDIFACT mapping:

```

UNH+1+DESADV:D:96A:UN'
BGM+351+12345678'
...
CPS+1'
PAC+2++2032::92' // 2 Handling units
QTY+52:100:PCE' // Quantity per pack: 100
PCI+17+++S::10' // S - Single packaging
GIR+3+1111' // Package Nr.
GIR+3+1112' // Package Nr.
PAC+1++2032::92'
QTY+52:120:PCE'
PCI+17+++S::10'
GIR+3+3311'
LIN+1++PART_NUMBER:IN' // Delivery note position 1
...
QTY+12:320:PCE' // 2 *100 + 120 = 320
...
UNT+82+1'
    
```

Example 1b, (3 boxes, different part numbers)

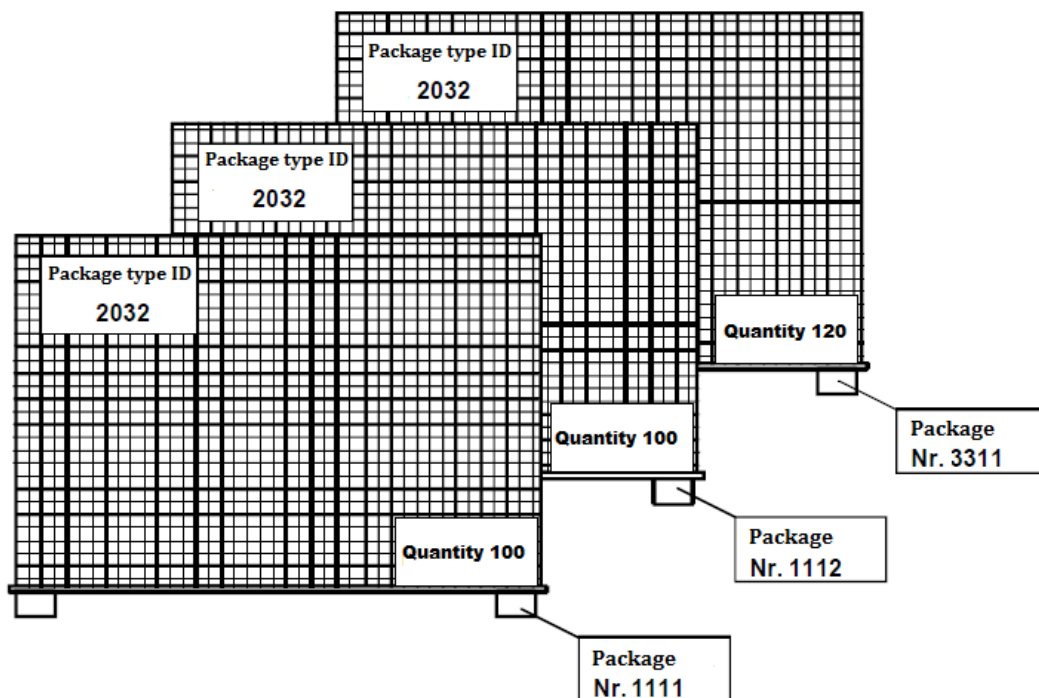

EDIFACT mapping:

```

UNH+1+DESADV:D:96A:UN'
BGM+351+12345678'
...
CPS+1'
PAC+1++2032::92' // 2 Handling units
QTY+52:100:PCE' // Quantity per pack: 100
PCI+17+++S::10' // S - Single packaging
GIR+3+1111' // Package Nr.
GIR+3+1112' // Package Nr.
LIN+1++PART_NUMBER1:IN' // Delivery note position 1
...
QTY+12:200:PCE' // 2 * 100 = 200
...
CPS+2'
PAC+1++2032::92'
QTY+52:120:PCE'
PCI+17+++S::10'
GIR+3+3311'
LIN+2++PART_NUMBER2:IN' // Delivery note position 2
...
QTY+12:120:PCE' // 1 * 120 = 120
UNT+82+1'
    
```

Example 2, (1 box, different part numbers – **Beipack** packaging)

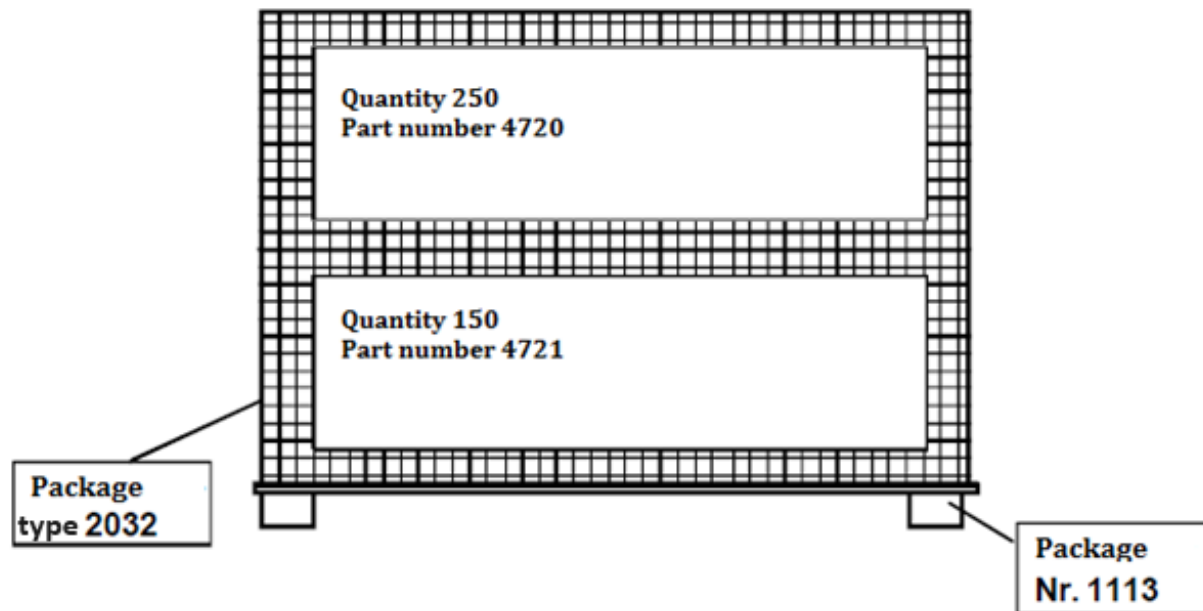

EDIFACT mapping:

```

UNH+1+DESADV:D:96A:UN'
BGM+351+12345678'
...
CPS+1'
PAC+1++2032::92' // 1 Handling unit
PCI+17+++G::10' // G – Mixed packaging
GIN+ML+1113' // Package Nr.
PAC+1++Beipack::92' // 1 Handling unit Beipack
QTY+52:250:PCE' // Quantity per pack: 250
PCI+17+++S::10' // S – Single packaging
GIR+3' // Empty GIR+3
LIN+1++4720:IN' // Delivery note position 1
...
QTY+12:250:PCE' // 1*250 = 250
...
CPS+2'
PAC+0++2032::92'
PCI+17+++G::10'
GIN+ML+1113'
PAC+1++Beipack::92'
QTY+52:150:PCE'
PCI+17+++S::10'
GIR+3'
LIN+2++4721:IN' // Delivery note position 2
...
QTY+12:150:PCE'
...

```

UNT+82+1'

Example 3a, (boxes with the same part number on a pallet – Master packaging)

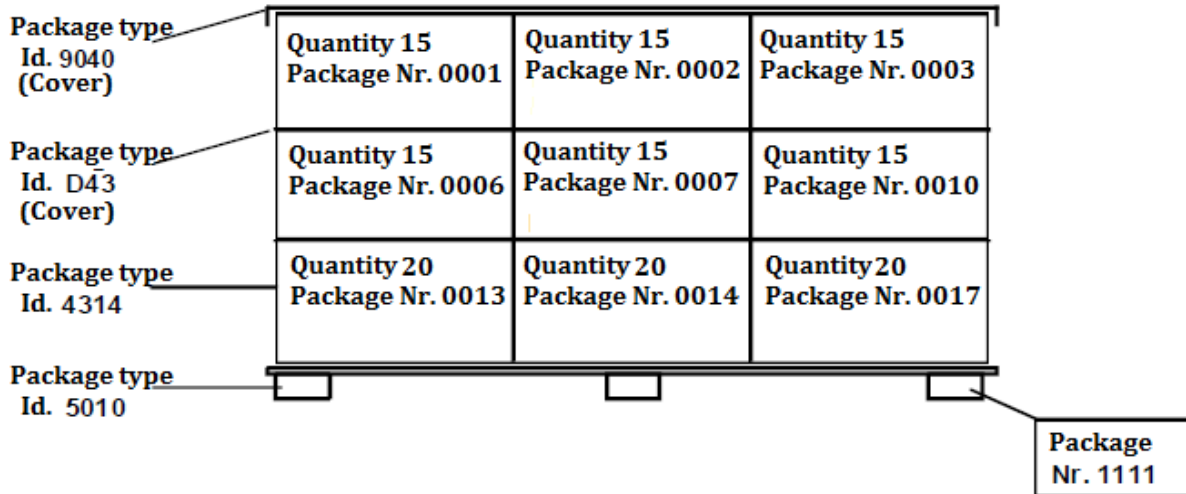

EDIFACT mapping:

```

UNH+1+DESADV:D:96A:UN'
BGM+351+12345679'
...
CPS+1'
PAC+1++5010::92' // 1 Handling unit
PCI+17+++M::10' // M – Master packaging
GIN+ML+1111' // Package Nr.
PAC+6++4314::92' // 6 Handling units
QTY+52:15:PCE' // Quantity per pack: 15
PCI+17+++S::10' // S – Single packaging
GIR+3+0001' // Package Nr.
GIR+3+0002' // Package Nr.
GIR+3+0003' // Package Nr.
GIR+3+0006' // Package Nr.
GIR+3+0007' // Package Nr.
GIR+3+0010' // Package Nr.
PAC+3++4314::92'
QTY+52:20:PCE'
PCI+17+++S::10'
GIR+3+0013'
GIR+3+0014'
GIR+3+0017'
PAC+9++D43::92' // 9 covers for the Single HUs
PAC+1++9040::92' // 1 cover for the Master HU
LIN+1++4712:IN' // Delivery note position 1
...
QTY+12:150:PCE' // 6*15 + 3*20 = 150
...
UNT+82+1'
    
```

Example 3a/2, (boxes with the same part number on different pallets – Master packaging)

EDIFACT mapping:

```
UNH+1+DESADV:D:96A:UN'  
BGM+351+12345679'  
...  
CPS+1'  
PAC+1++5010::92' // 1 Handling unit  
PCI+17+++M::10' // M – Master packaging  
GIN+ML+1111' // Package Nr.  
PAC+6++4314::92' // 6 Handling units  
QTY+52:15:PCE' // Quantity per pack: 15  
PCI+17+++S::10' // S – Single packaging  
GIR+3+0001' // Package Nr.  
...  
PAC+6++D43::92' // 6 covers for the Single HUs  
PAC+1++9040::92' // 1 cover for the Master HU  
PAC+1++5010::92' // 1 Handling unit  
PCI+17+++M::10' // M – Master packaging  
GIN+ML+1112' // Package Nr.  
PAC+1++4314::92' // 1 Handling units  
QTY+52:20:PCE' // Quantity per pack: 20  
PCI+17+++S::10' // S – Single packaging  
GIR+3+0013' // Package Nr.  
PAC+1++9040::92' // 1 cover for the Master HU  
LIN+1++4712:IN' // Delivery note position 1  
...  
QTY+12:110:PCE' // 6*15 + 1*20 = 110  
...  
UNT+82+1'
```

Example 3a/3, (boxes with different part numbers on different pallets – Master packaging)

EDIFACT mapping:

```
UNH+1+DESADV:D:96A:UN'  
BGM+351+12345679'  
...  
CPS+1'  
PAC+1++5010::92' // 1 Handling unit  
PCI+17+++M::10' // M – Master packaging  
GIN+ML+1111' // Package Nr.  
PAC+6++4314::92' // 6 Handling units  
QTY+52:15:PCE' // Quantity per pack: 15  
PCI+17+++S::10' // S – Single packaging  
GIR+3+0001' // Package Nr.  
...  
PAC+6++D43::92' // 6 covers for the Single HUs  
PAC+1++9040::92' // 1 cover for the Master HU  
LIN+1++4712:IN' // Delivery note position 1  
...  
QTY+12:90:PCE' // 6*15 = 90  
...  
CPS+2'  
PAC+1++5010::92' // 1 Handling unit  
PCI+17+++M::10' // M – Master packaging  
GIN+ML+1112' // Package Nr.  
PAC+1++4314::92' // 1 Handling units  
QTY+52:20:PCE' // Quantity per pack: 20  
PCI+17+++S::10' // S – Single packaging  
GIR+3+0013' // Package Nr.  
PAC+1++9040::92' // 1 cover for the Master HU  
LIN+1++5784:IN' // Delivery note position 1  
...  
QTY+12:20:PCE' // 1*20 = 20  
...  
UNT+82+1'
```

Example 3b, (boxes without package numbers on a pallet, same part number)

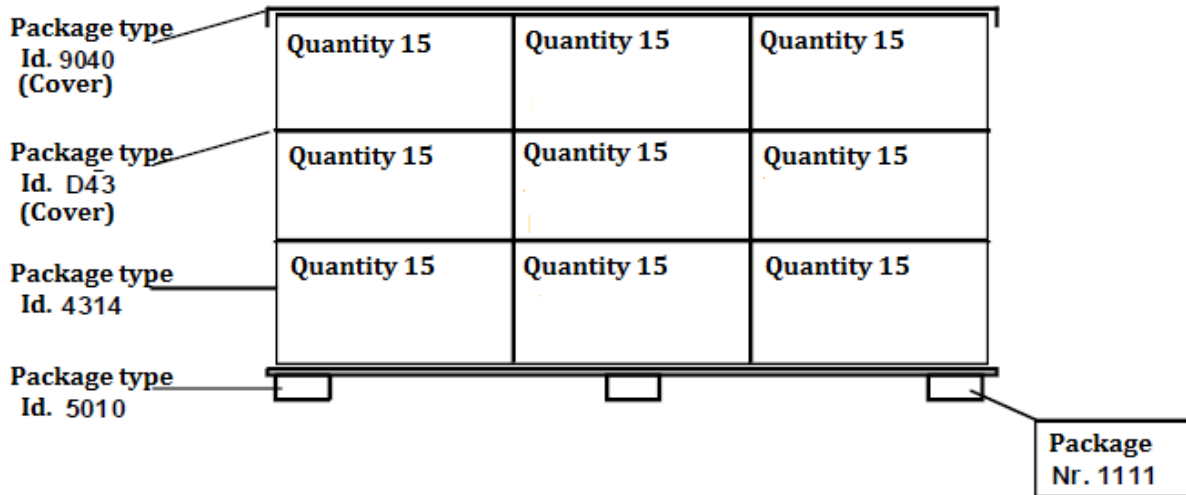

EDIFACT mapping:

```

UNH+1+DESADV:D:96A:UN'
BGM+351+12345679'
...
CPS+1'
PAC+1++5010::92' // 1 Handling unit
QTY+52:150:PCE' // Quantity per pack: 150
PCI+17+++S::10' // S - Single packaging
GIR+3+1111' // Package Nr.
PAC+9++4314::92' // Box
PAC+9++D43::92' // Cover
PAC+1++9040::92' // Cover
LIN+1++4712:IN' // Delivery note position 1
...
QTY+12:150:PCE' // 1*150 = 150
...
UNT+82+1'
    
```

Example 4, (boxes with different part numbers on a pallet – Mixed packaging)

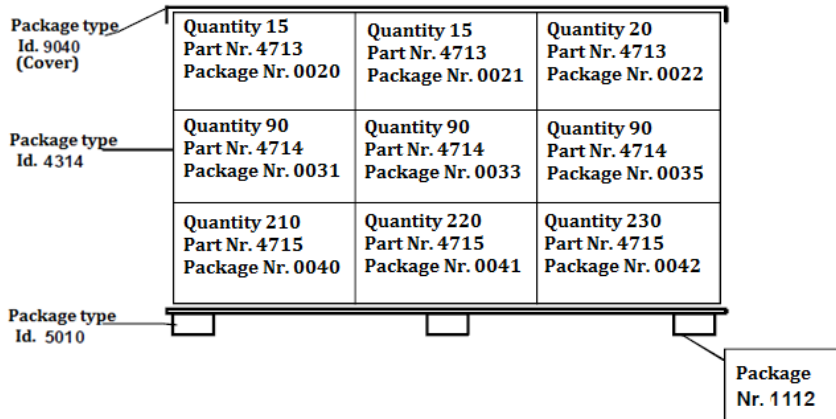

EDIFACT mapping:

UNH+1+DESADV:D:96A:UN'
BGM+351+12345679'

```

...
CPS+1'
PAC+1++5010::92' // 1 Handling unit
PCI+17+++G::10' // G – Mixed packaging
GIN+ML+1112' // Package Nr.
PAC+2++4314::92' // 2 Handling units
QTY+52:15:PCE' // Quantity per pack: 15
PCI+17+++S::10' // S – Single packaging
GIR+3+0020' // Package Nr.
GIR+3+0021' // Package Nr.
PAC+1++4314::92' // 1 Handling unit
QTY+52:20:PCE' // Quantity 20
PCI+17+++S::10' // S – Single packaging
GIR+3+0022' // Package Nr.
PAC+1++9040::92' // 1 Cover
LIN+1++4713:IN' // Delivery note position 1
...
QTY+12:50:PCE' // 2*15 + 20 = 50
...
CPS+2'
PAC+0++5010::92' // 0 Handling unit!
PCI+17+++G::10'
GIN+ML+1112'
PAC+3++4314::92'
QTY+52:90:PCE'
PCI+17+++S::10'
GIR+3+0031'
GIR+3+0033'
GIR+3+0035'
LIN+2++4714:IN' // Delivery note position 2
...
QTY+12:270:PCE'
...

```

```

...
CPS+3'
PAC+0++5010::92' // 0 Handling unit!
PCI+17+++G::10'
GIN+ML+1112'
PAC+1++4314::92'
QTY+52:210:PCE'
PCI+17+++S::10'
GIR+3+0040'
PAC+1++4314::92'
QTY+52:220:PCE'
PCI+17+++S::10'
GIR+3+0041'
PAC+1++4314::92'
QTY+52:230:PCE'
PCI+17+++S::10'
GIR+3+0042'
LIN+3++4715:IN' // Delivery note position 3
...
QTY+12:660:PCE'
...
UNT+82+1'

```